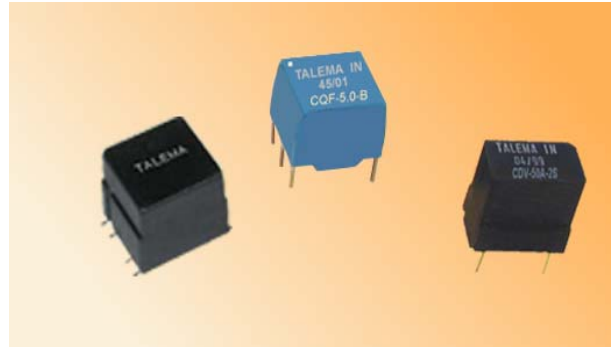

CD & CQ Series • CM Interface Chokes for Data and Signal Lines
Features

- High attenuation over a wide frequency range
- Low interwinding and coupling capacitance
- Wide inductance range
- Excellent quality at extremely competitive price due to high volume production
- Manufactured in an ISO 9001:2015
ISO 14001:2015 certified Talema facility
- Other inductance values available upon request
- Fully RoHS & REACH Compliant and SMD Components meet lead free reflow level J-STD-020C

Electrical Specifications @ 25°C

Nominal Voltage: 42Vac (50/60Hz), 80Vdc

Operating Temperature: -25° to +85°C

Storage Temperature: -40° to +125°C

Climatic category: according to IEC68-1 25/85/56

Test voltage between windings: 500 Vrms

Test frequency:

Nominal Inductance: Measured @ 10KHz/100mVrms

Leakage Inductance: Measured @ 100KHz/100mVrms

Part Number	L _N (µH) ±30%	I _N (mA)	L _L (µH)	R _{CU} (mOhms)	V _P (Vrms)	Windings per Core	Package	Schematic
CD Series - Double Chokes for EMI noise suppression								
CD__-1.0-A	1000	600	0.25	190	500	2	F / V / J	A
CD__-1.7-A	1700	550	0.42	200	500	2	F / V / J	A
CD__-2.2-A	2200	350	0.45	300	500	2	F / V / J	A
CD__-3.3-A	3300	350	0.50	370	500	2	F / V / J	A
CD__-4.7-A	4700	350	0.40	600	500	2	F / V / J	A
CD__-6.8-A	6800	350	0.55	510	500	2	F / V / J	A
CD__-10-A	10000	350	0.65	620	500	2	F / V / J	A
CD__-12-A	12000	300	0.70	680	500	2	F / V / J	A
CD__-15-A	15000	300	0.55	720	500	2	F / V / J	A
CD__-22-A	22000	300	0.85	920	500	2	F / V / J	A
CD__-28-A	28000	300	0.95	1020	500	2	F / V / J	A
CD__-33-A	33000	300	1.90	1120	500	2	F / V / J	A
CD__-50-A	50000	300	1.35	1800	500	2	F / V / J	A
CD__-70-A	70000	300	2.50	2100	500	2	F / V / J	A
CQ Series - Quad Chokes for EMI noise suppression								
CQ__-1.0-B	1000	400	0.30	200	500	4	F / V / J	B
CQ__-1.7-B	1700	350	0.40	260	500	4	F / V / J	B
CQ__-2.2-B	2200	300	0.45	310	500	4	F / V / J	B
CQ__-3.3-B	3300	300	0.50	380	500	4	F / V / J	B
CQ__-5.0-B	5000	300	0.30	430	500	4	F / V / J	B
CQ__-6.8-B	6800	300	0.55	850	500	4	F / V / J	B
CQ__-10-B	10000	300	0.65	1060	500	4	F / V / J	B
CQ__-12-B	12000	250	0.65	1120	500	4	F / V / J	B
CQ__-58-B	58000	200	1.40	2400	500	4	F / V / J	B
CQ__-90-B	90000	150	2.00	4150	500	4	F / V / J	B

When ordering Series CD or CQ, use suffix "F", "V" or "J" to designate desired package style.

CDF/CQF = Flat package, through-hole;

CDV/CQV = Vertical package, through hole;

CDJ/CQJ = Flat package, surface mount device

See following page for dimensions, schematics and typical impedance curves

Packaging Style and Impedance Performance

Package Style

CDF/CQF

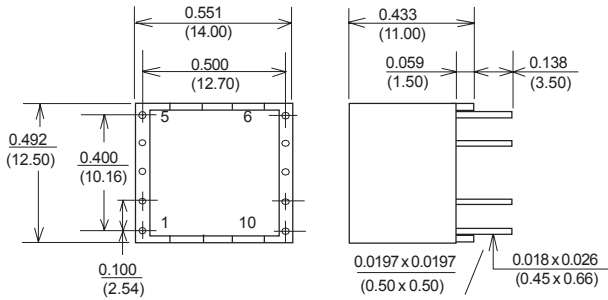

CDJ/CQJ

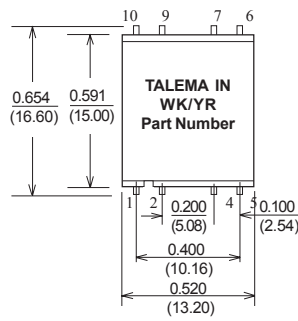

Suggested Pad Layout

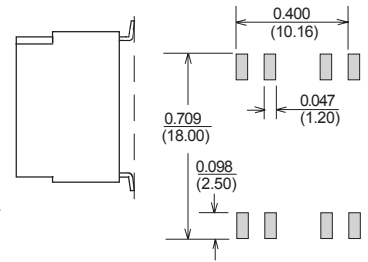

CDV/CQV

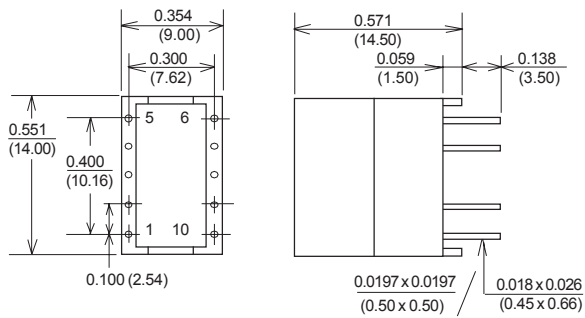

Schematics

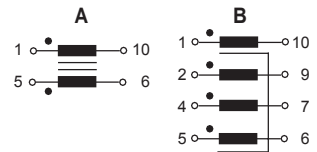

Note: Parts will be supplied with only the pins shown on Schematic A (types CDF, CDV, & CDJ) and Schematic B (types CQF, CQV & CQJ)

Dimensions: Inches (Millimeters)

Tolerance: ± 0.010 (0.25) unless specified otherwise
Surface Coplanarity will be 0.004(0.10) maximum

Impedance Performance - CQx & CDx Series Double Chokes

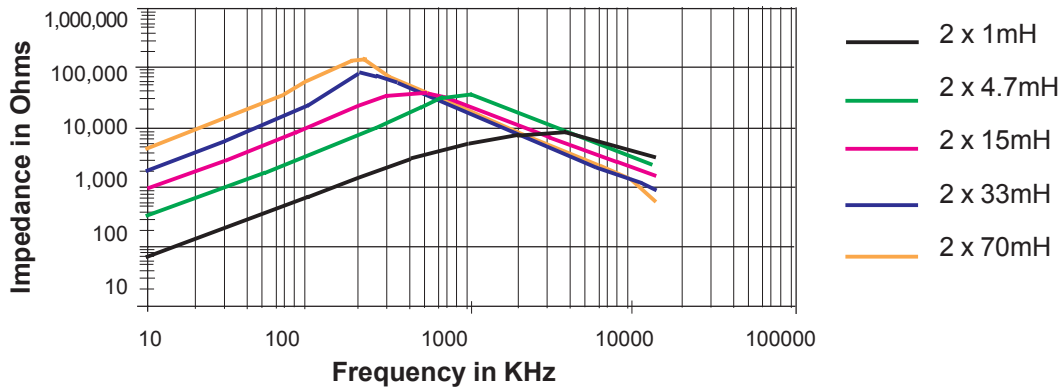

CQx & CDx Series Quad Chokes

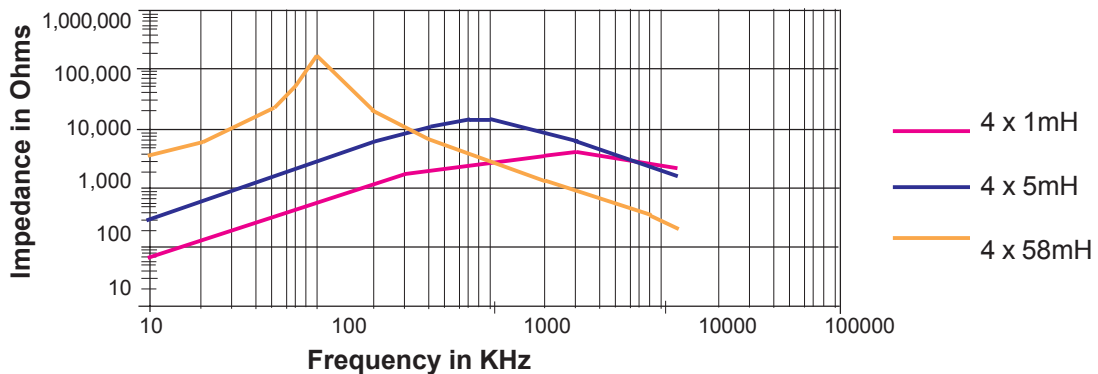

Regional Locations - Design, Manufacturing, Sales & Marketing

Talema Group Regional Offices

North America

United States
(Sales & Marketing)

Talema Group, LLC
PO Box 935
900 Innovation Drive
Suite 120, Rolla
Missouri 65402
Tel: +1 573-303-3675
E-Mail:
sales@talemagroup.com
Web: www.talema.com

Asia

India
(Design, Manufacturing, Sales & Marketing)

Administrative Office
Talema Electronic India Private Limited
Door No. 221, 1st and 2nd Floor
KJ Plaza, Opp.to Vidya Mandir School
Meyanoor Main Road
Salem - 636 004 Tamil Nadu INDIA
Tel: +91 427 - 243 3100
Fax: +91 427 - 243 3109
E-Mail: talema@talemaindia.net
Web: www.talema.com

Factory Premises
Talema Electronic India Private Limited
Plot Nos. 30, 31 Electrical and Electronic
Industrial Estate
Suramangalam
Salem - 636 005 Tamil Nadu INDIA
Tel: +91 427 - 243 3000
E-Mail: talema@talemaindia.net
Web: www.talema.com

Europe

Germany
(Design, Sales & Marketing)

Talema Elektronik GmbH
Sembdnerstr. 5
82110 Germering
Tel: +49 89 - 841 00 - 0
Fax: +49 89 - 841 00 25
E-Mail: info@talema.de
Web: www.talema.com

Ireland
(Design, Sales & Marketing)

Nuvotem TEO
Units W & X, Gweedore Business Park
Derrybeg, Letterkenny, Co. Donegal
Tel: +353 (0) 74 95 48666
Fax: +353 (0) 74 95 48139
E-Mail: info@nuvotem.com
Web: www.nuvotem.com

Czech Republic
(Design, Manufacturing, Sales & Marketing)

NT Magnetics s.r.o.
Chebská 27
322 00 Plzeň
Tel: +420 377 - 338 351
Fax: +420 377 - 338 350
E-Mail: talema@talema.cz
Web: www.ntmagnetics.cz

Locations of Talema Group Regional Offices

